

Mainly introduction

Projoy PEDB series PV junction box, is suitable for 1-20KW power, 1-2*MPPT input, each with a surge protector, lightning protection device and circuit breaker, providing PV system with short circuit protection, lightning protection and grounding protection.

Technical characteristics

- Polycarbonate body shell with IP66 protection grade can meet external installation requirements: prevent ultraviolet, water, dust, acid & alkali, salt fog and corrosion. Box has the very high robustness, the impact strength IK08 and at the same time is light enough to easily carry. Transparent cover can be directly observed the body internal state, ease of maintenance.
- Internal parts are reliable components, have TUV, CCC, CE certification, in accordance with IEC standard
- Body internal is clear, reasonable wiring and tidy, convenient to installation.
- The cable connector is IP68 protection grade and suit for outdoor use. And waterproof cable connector & MC4 connector are optional.
- Allow multiple PV array to access at the same time, the biggest current 32A each, so satisfy different users.
- Wide range of DC voltage input: Use professional DC high voltage circuit breaker, and max voltage is 1000V, safe and reliable.
- Equipped with PV certificated lightning protection and surge protection in both positive & negative, so double security.
- With professional testing laboratory and R&D facilities, ISO9001 certificated quality control system, we ensure that every Projoy products safe and reliable. Also we' re glad to customize the junction box according to actual PV system and provide exclusive solution.

Recommandations and precautions

- This material should be installed under the guidance of a qualified technician
- Please note that the installation need two kinds of electric tension: **PHOTOVOLTAIC AND PUBLIC DISTRIBUTION NETWORK** ,so it can be checked the power cut better before the operation or the junction box.
- It is necessary to accomplish a control campaign which is tightening the cables after vibration and shock which can happen during the transportation of the box. Also press the fuse of lightning arresters to ensure proper positioning.
- Although the fuse of lightning arresters will be seperated under full load ,we recommend you to cut the circuit before there placement to avoid all risk of burning that may occur via conduction terminals.
- L' UTE C15-712-1 recommend to use same type and same mark for the assembly of male/female connector.

PEDB-300SS-1

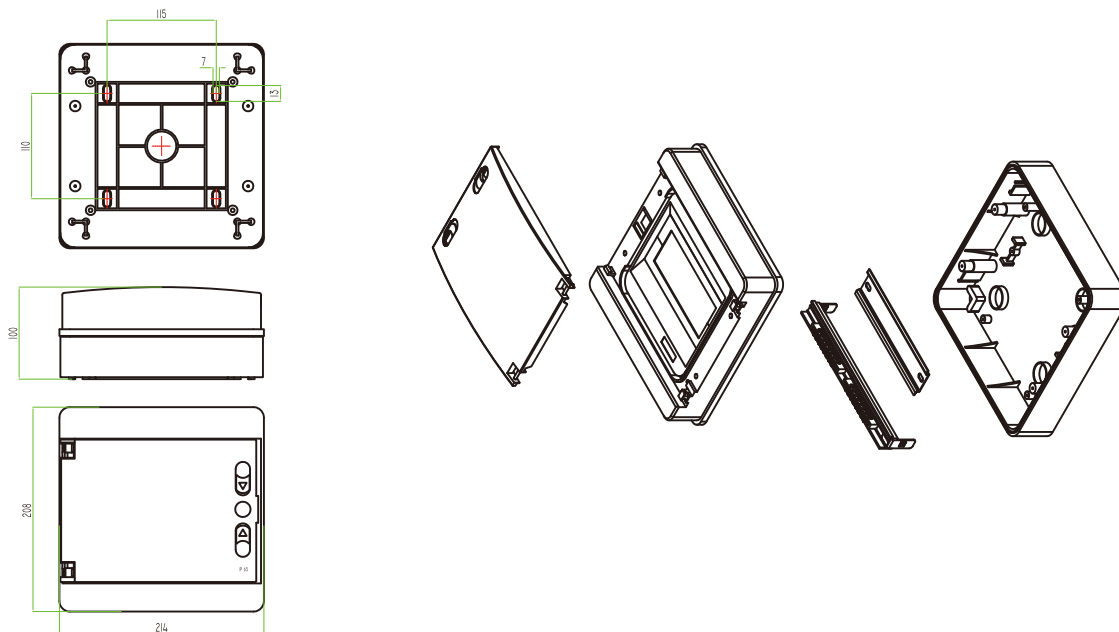

Schematic

