

Dimensions

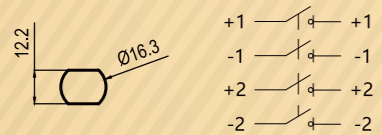
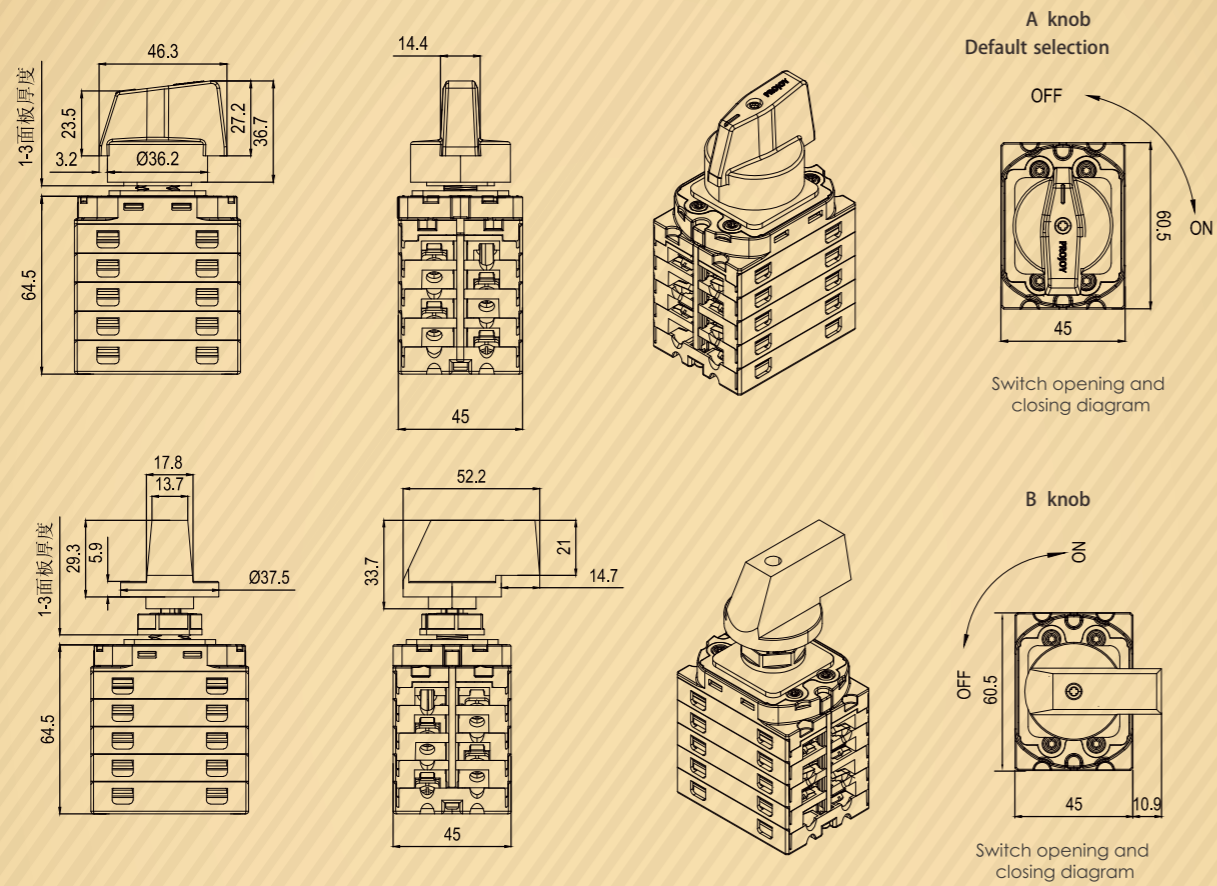

Mounting Hole Contact Configuration

SINGLE HOLE MOUNTING
DC ISOLATOR

PEDS40/55-HM-X





Product Features











- 1、 Reliable switching up to 1500V DC21B.
- 2、 Single-channel current can up to 40-55A.
- 3、 Positive contact, anti-contact optional.
- 4、 Single Hole Mounting.
- 5、 Modular design, optional 2-8 levels.
- 6、 Pass through the international certification like IEC/SAA / CE/TUV etc.
- 7、 Imported seals make sure the installation machines reach IP66 standard.

Technical data

Data according to IEC60947-3(ed.3.2):2015, UL508i, GB14048.3 utilization category DC-PV0/DC-PV1

Main Parameters		Type	HM40	HM55
Rated insulation voltage	U_i	V	1500V	1500V
Rated thermal current	I_{the}	A	40A	55A
rated impulse withstand voltage	U_{imp}	V	8000V	8000V
rated short-time withstand current (1s)	I_{cw}	2, 4, 6, 8	1200	1400
		2H, 3H, 4H	2000	2400
rated short-circuit making capacity	I_{cm}	2, 4, 6, 8	1200	1400
		2H, 3H, 4H	2000	2400
rated conditional short-circuit current	I_{cc}	A	5000A	5000A
Max. fuse size	g_L (gG)	A	125	160
Maximum cable cross sections (incl. jumper)				
solid or standard		mm ²	4-16	4-16
flexible		mm ²	4-10	4-10
flexible (+ multicore cable end)		mm ²	4-10	4-10
Torque				
Tightening torque terminal screws M4.		Nm	1.2-1.8	
Tightening torque panel mounting screws ST4.2(304 stainless steel)		Nm	NA	
Tightening torque single hole mounting nut M16		Nm	2.0-2.5	
Tightening torque knob screws M3		Nm	0.5-0.7	
Switching on or off torque		Nm	0.9-1.9	
Power loss per switch Max.				
2		W	4	6
4		W	8	12
6		W	12	18
8		W	16	24
2H		W	2	3
3H		W	3	4.5
4H		W	4	6
General parameters				
method of mounting	Single Hole Mounting			
type of knob	A		B	
				
knob positions	OFF at 12 hr, ON at 3 hr; (OFF at 9 hr, ON at 12 hr optional)			
Mechanical life	10,000			
number of DC poles	2 or 4 (6/8 pole optional)			
Distance of contacts (per pole)	mm	8		
Operation temperature	°C	-40 to +70		
Storage temperature	°C	-40 to +85		
Pollution degree	2			
Overvoltage category	III			
IP rating of shafte and mounting nut	IP66			

Technical data

Data according to IEC60947-3(ed.3.2):2015, utilization category DC-PV0/DC-PV1								Poles in series	No. of Strings	Part Number	Contact Configuration
500V	600V	700V	800V	900V	1000V	1200V	1500V				
19	15	10	8	6	4	/	/	1	1	PEDS150R-HM40-1	
25	20	15	10	8	6	/	/	1	1	PEDS150R-HM55-1	
40	40	35	30	25	20	10	6	2	1	PEDS150R-HM40-2	
55	55	55	45	35	25	15	8	2	1	PEDS150R-HM55-2	
40	40	35	30	25	20	10	6	3	1	PEDS150R-HM40-3	
55	55	55	45	35	25	15	8	3	1	PEDS150R-HM55-3	
72	64	35	30	25	20	10	6	4	1	PEDS150R-HM40-2H	
85	80	55	45	35	25	15	8	4	1	PEDS150R-HM55-2H	
40	40	35	30	25	20	10	6	4	2	PEDS150R-HM40-4	
55	55	55	45	35	25	15	8	4	2	PEDS150R-HM55-4	
40	40	40	40	40	40	40	30	4	1	PEDS150R-HM40-4S	
55	55	55	55	55	55	55	40	4	1	PEDS150R-HM55-4S	
40	40	40	40	40	40	40	30	4	1	PEDS150R-HM40-4T	
55	55	55	55	55	55	55	40	4	1	PEDS150R-HM55-4T	
40	40	40	40	40	40	40	30	4	1	PEDS150R-HM40-4B	
55	55	55	55	55	55	55	40	4	1	PEDS150R-HM55-4B	
40	40	35	30	25	20	10	6	6	3	PEDS150R-HM40-6	
55	55	55	45	35	25	15	8	6	3	PEDS150R-HM55-6	
40	40	35	30	25	20	10	6	8	4	PEDS150R-HM40-8	
55	55	55	45	35	25	15	8	8	4	PEDS150R-HM55-8	